

Data sheet

RP01302VBWN Type 169

Page 1/6

P/N
31169102

2026/04/27

Illustrations

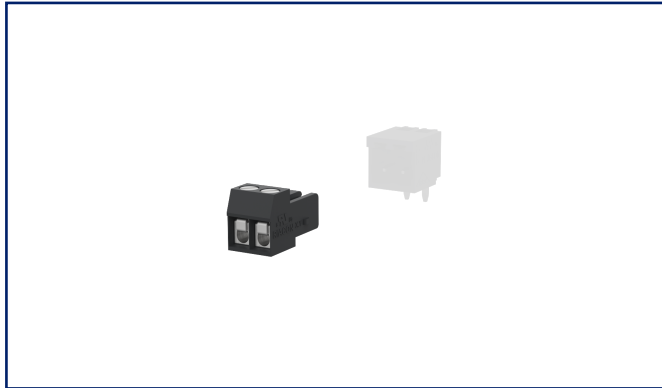

Dimensional drawing as an example

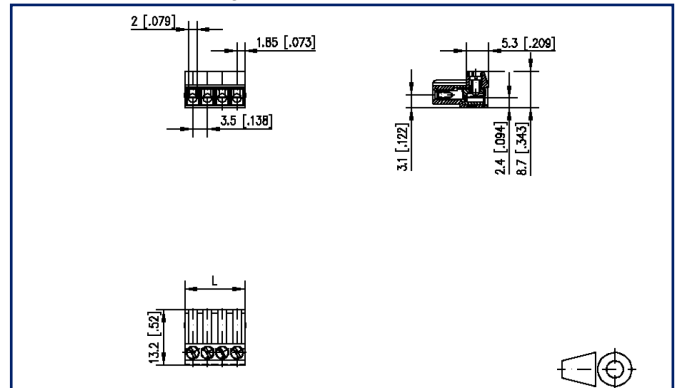

See enlarged drawings at the end of document

Product specification

- screw type terminal block, pluggable
- centerline 3.50 mm, direction of connection vertical 0°
- wire protector
- color black
- wire entry codeable side perpendicular to plug direction



Data sheet
RP01302VBWN Type 169

Technical Data



General Data

Tightening torque SEV	0.15 Nm		
Tightening torque UL	1.3 lb-in		
pole size	2		
Insulating material class	CTI 600		
clearance/creepage dist.	2 mm		
Protection category	IP20		
Insul. strip length	5 mm		
Rated current	5 A		
Overvoltage category	III	III	II
Pollution degree	3	2	2
Rated voltage	32 V	250 V	250 V
Rated test voltage	2.5 kV	2.5 kV	2.5 kV

Terminal data

rat.wiring solid AWGmax	0.08 mm ² - 1.5 mm ² / AWG 28 - AWG 16
rat.wiring strand.AWGmax	0.08 mm ² - 1 mm ² / AWG 28 - AWG 16

Approvals

 V / A / AWG	150 / 10 / 28 - 16
approval UL - File No.	E121004
	125 V / 2.5 kV / 5 A

Material

insulating material	PA66
flammability class	V0
contact material	CuNiZn
terminal body thread	M2
terminal body material	CuZnPb
terminal body surface	Cu + Ni
screw thread	M2
screw material	8,8
screw surface	Zn Cr(VI)-frei/free
wire protector material	CuNiZn

Data sheet
RP01302VBWN Type 169

Page 3/6

P/N
31169102

2026/04/27

Technical Data

Glow-Wire Flammability GWFI	960 °C acc. to IEC 60695-2-12
Glow-Wire Flammability GWIT	775 °C acc. to IEC 60695-2-13

Climatic Data

upper limit temperature	105 °C
lower limit temperature	-40 °C

general

Tolerance	ISO 2768 -mH
-----------	--------------

Application note

This product is a standard product of METZ CONNECT. METZ CONNECT is not aware of the specific intended use of the goods by the Customer or any customers of the Customer. The Customer guarantees that it has fully and sufficiently tested the use of the goods and any product modifications, product changes or product enhancements with regard to the specific intended use in accordance with the state of the art or in any other way. At METZ CONNECT's request, the Customer shall submit and make available meaningful evidence (e.g. test and laboratory protocols, certifications, etc.).



Data sheet
RP01302VBWN Type 169

Page 4/6

P/N
31169102

2026/04/27

Accessories

P/N	Designation
720243-01-3	Coding star orange
720243-02-4	Coding star gray



Data sheet
RP01302VBWN Type 169

Page 5/6

P/N
31169102

2026/04/27

Counterpart

P/N	Designation
311801	PT013xxHBBN Typ 180
311811	PT013xxVBBN Typ 181
311821	PT113xxHBBN Type 182
311831	PT113xxVBBN Type 183
311861	PT123xxHDBN Typ 186
311871	Typ 187 PT123 xxVDBO



Illustrations

Dimensional drawing as an example

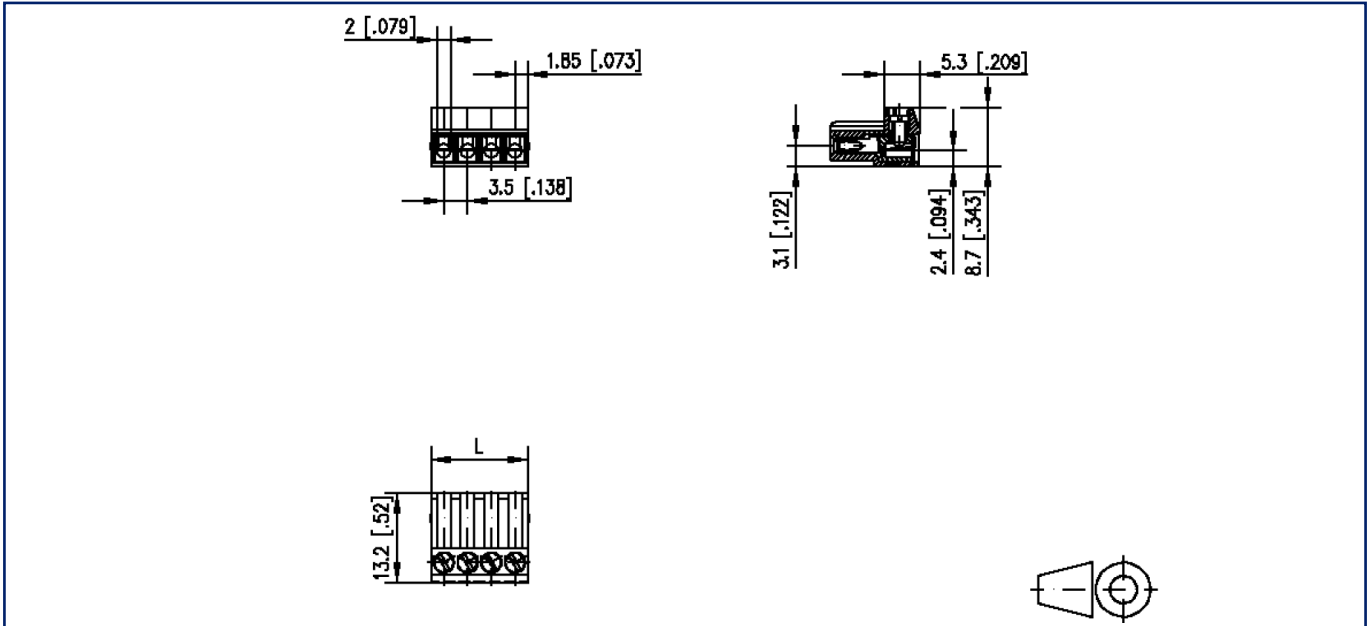

$L = (\text{pole size} - 1) \times \text{centerline} + 3.7 \text{ mm} [0.146]$

