

Data sheet

RP01516VBLC Type 349

Page 1/6

P/N
31349116

2026/03/30

Illustrations

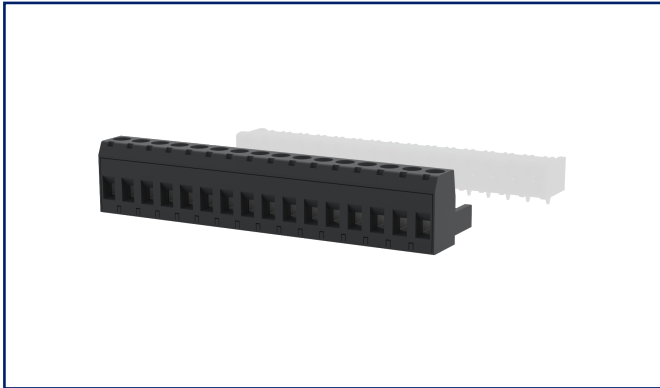

Dimensional drawing as an example

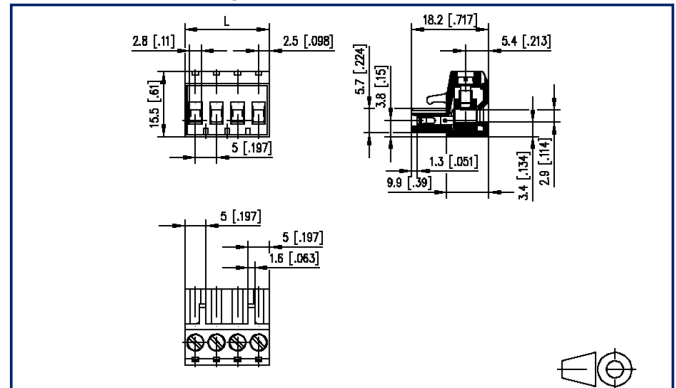



See enlarged drawings at the end of document

Product specification

- screw type terminal block, pluggable
- centerline 5.00 mm, direction of connection vertical 0°
- lift system, fittable without loss of poles
- color black
- wire entry codeable side perpendicular to plug direction

Data sheet
RP01516VBLC Type 349

Technical Data

General Data			
Tightening torque SEV	0.5 Nm		
Tightening torque UL	4.4 lb-in		
pole size	16		
Insulating material class	CTI 600		
clearance/creepage dist.	3.6 mm		
Protection category	IP20		
Insul. strip length	8 mm		
Rated current	12 A		
Overvoltage category	III	III	II
Pollution degree	3	2	2
Rated voltage	160 V	400 V	400 V
Rated test voltage	4 kV	4 kV	4 kV
Terminal data			
rat.wiring solid AWGmax	0.08 mm ² - 2.5 mm ² / AWG 28 - AWG 12		
rat.wiring strand.AWGmax	0.08 mm ² - 2.5 mm ² / AWG 28 - AWG 12		
Approvals			
extended wiring UL	2 AWG 16-18, or 1 AWG 16 stranded with 1 AWG 18 solid, or 1 AWG 16 stranded with 1 AWG 18 stranded		
 V / A / AWG	300 / 16 / 28 - 12		
approval UL - File No.	E121004		
	320 V / 4 kV / 13.5 A		
Material			
insulating material	PA66		
flammability class	V0		
contact material	CuSn		
Contact surface	Sn		
terminal body thread	M3		
terminal body material	CuZnPb		
terminal body surface	Ni		
screw thread	M3		

Data sheet
RP01516VBLC Type 349

Page 3/6

P/N
31349116

2026/03/30

Technical Data

screw material	8,8
screw surface	Zn Cr(VI)-frei/free
Glow-Wire Flammability GWFI	960 °C acc. to IEC 60695-2-12
Glow-Wire Flammability GWIT	775 °C acc. to IEC 60695-2-13

Climatic Data

upper limit temperature	105 °C
lower limit temperature	-40 °C

general

Tolerance	ISO 2768 -mH
-----------	--------------

Application note

This product is a standard product of METZ CONNECT. METZ CONNECT is not aware of the specific intended use of the goods by the Customer or any customers of the Customer. The Customer guarantees that it has fully and sufficiently tested the use of the goods and any product modifications, product changes or product enhancements with regard to the specific intended use in accordance with the state of the art or in any other way. At METZ CONNECT's request, the Customer shall submit and make available meaningful evidence (e.g. test and laboratory protocols, certifications, etc.).

Data sheet
RP01516VBLC Type 349

Page 4/6

P/N
31349116

2026/03/30

Accessories

P/N	Designation
700025-01-9	Coding star white with a group of 6 coding pins



Data sheet
RP01516VBLC Type 349

Page 5/6

P/N
31349116

2026/03/30

Counterpart

P/N	Designation
311761_P	
311771_P	
312701_P	
312741_P	
312761_P	
312781_P	
312801_P	
313191_P	
313201_P	
313291_P	
313301_P	
313371_P	
313381_P	
314761_P	
314771_P	



Illustrations

Dimensional drawing as an example

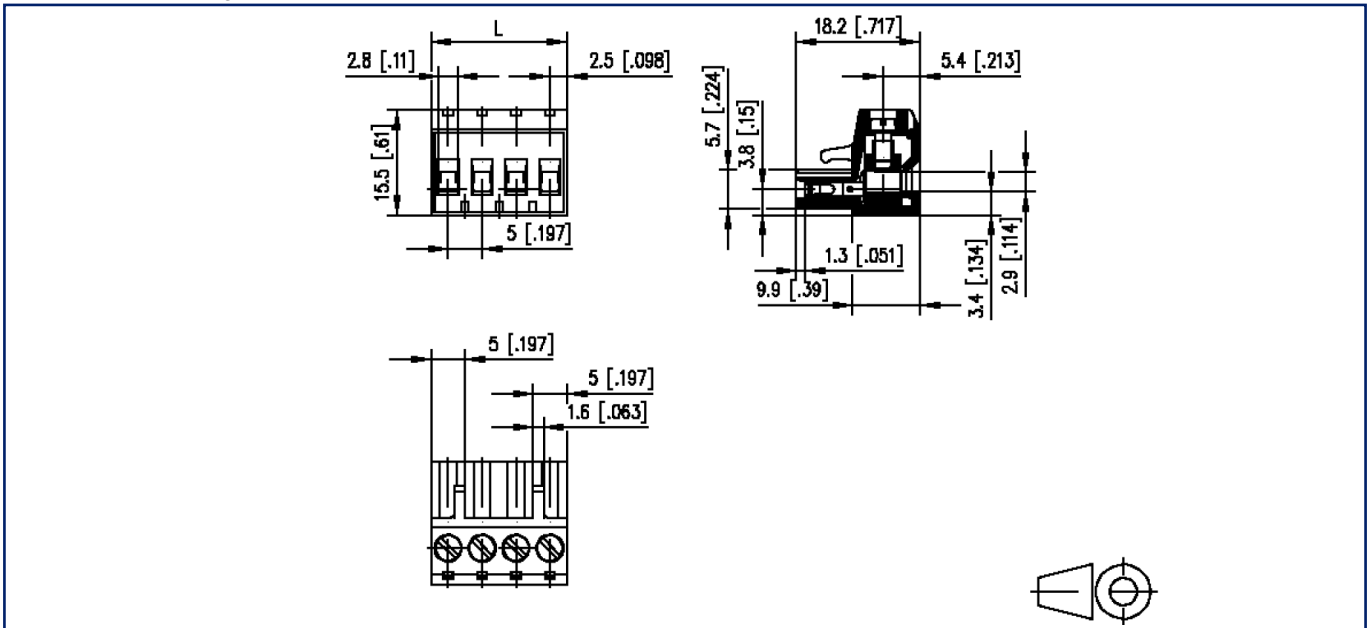

$L = (\text{pole size} - 1) \times \text{centerline} + 5 \text{ mm } [0.197]$